WJX SERIES

SHARPNESS WITH STABILITY
FOR HIGH EFFICIENCY MACHINING



RELIABILITY EVEN IN HIGH EFFICIENCY CONDITIONS



Innovative cutting edge design for stable milling

- WJX series – developed for reliability and economy even at high feed rates and high depths of cut
- Economical double-sided insert provides the capability for multi-functionality
- Excellent sharpness enables reduced cutting noise and provides long tool life

WJX

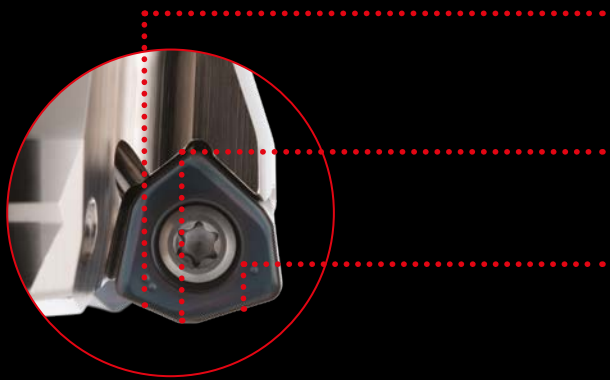

MINOR CUTTING EDGE

Stable chip formation, even at high ramping angles, is made possible with the straight cutting edge.

WIPER CUTTING EDGE

The wiper edge enables surface finishes that are more than sufficient for rough machining.

STRAIGHT CUTTING EDGE

The straight cutting edge extending to the maximum depth of cut (APMX) allows for high feed machining even at larger depths of cut.

HIGHLY RELIABLE CLAMPING SYSTEM

Prevents the insert from lifting

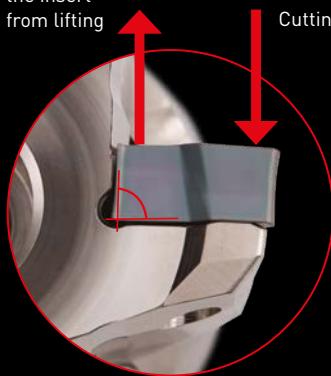

The dovetail pocket geometry prevents the insert from lifting and provides stable clamping without the use of a clamp bridge.

COMPLEX SHAPE FLANK FACE SUITABLE FOR RAMPING



SINGLE-SIDED

Positive insert, Ramping performance, Sharpness

DOUBLE-SIDED

Negative insert, Cost efficiency, Insert strength, Fracture resistance



1 Face milling

2 Shoulder milling

3 Helical milling

4 Pocket milling

5 Ramping

DOUBLE-SIDED INSERT HIGH FEED MILLING CUTTER

High feed radius milling cutter, with strong double-sided inserts. Exhibits low cutting resistance on workpiece entry. Maintains stability even during interrupted machining and at large depths of cut.

Material	DIN 41CrMo4
DCX	63
Vc (m/min)	150
fz (mm/t.)	1.5
ap (mm)	1.5
ae (mm)	31.5
Cutting mode	Single insert

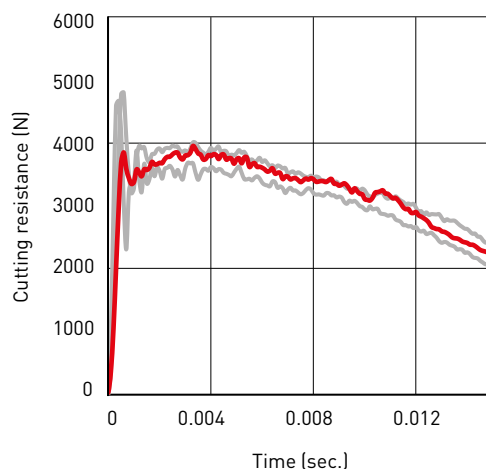

WJX produces low cutting resistance when entering the workpiece.

HIGH STRENGTH DUE TO INCREASED INSERT THICKNESS

Material	DIN 41CrMo4
DCX	63
Vc (m/min)	150
fz (mm/t.)	2.0
ap (mm)	2
ae (mm)	45
Cutting mode	Dry cutting Single insert

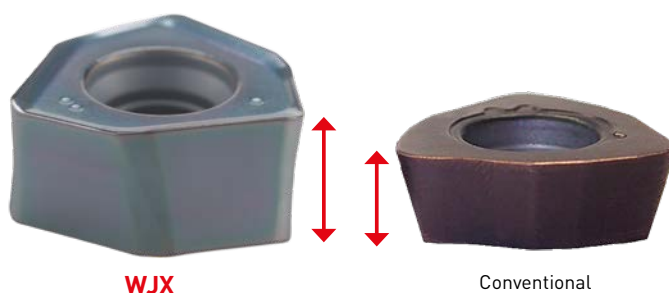

Cutting length 4.8 m



Cutting length 3.6 m

GOOD CHIP FORMATION

The cutting edge forms short chips that prevents chip jammin and tangling, as well as facilitating easy removal of the chips after machining.

Material	DIN 41CrMo4
DCX	63
Vc (m/min)	150
fz (mm/t.)	2.0
ap (mm)	2
ae (mm)	45
Cutting mode	Dry cutting Single insert



WJX



Conventional

WJX

GRADES AND CHIPBREAKERS

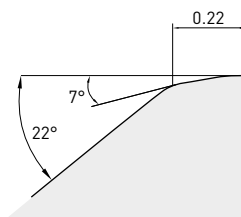

L-BREAKER

Recommended for machining that requires reduced cutting loads or under unstable clamping situations.

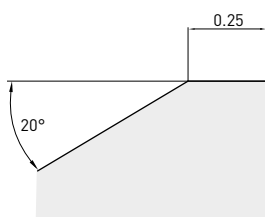

M-BREAKER

Outstanding balance of cutting edge sharpness and stability. First choice all-rounder, suitable for a variety of materials and applications.

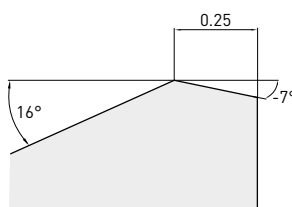

R-BREAKER

Increased fracture resistance due to tougher cutting edges for reliable machining, even for interrupted cutting conditions.

TOUGH-Σ TECHNOLOGY



(Graphical representation)

Base layer high Al-(Al, Ti)N

The new technology Al-(Al, Ti)N coating provides stabilisation of the high hardness phase and succeeds in dramatically improving wear, crater and welding resistance.

Multi-layering of the coating prevents any cracks penetrating through to the substrate.

WJX

INSERT GRADES FOR A WIDE RANGE OF MATERIALS

P	CVD	PVD	M	CVD	PVD	K	CVD	PVD	S	PVD	H	PVD
P10			M10			K10			S10		H10	
P20	MC7020	MV1020	M20	MC7020	MV1030	K20	MV1020		S20	MP9120	VP15TF	H20
P30	MV1030	MP6120	M30		MP7130	K30			S30		MP9130	VP15TF
P40		VP15TF	M40		VP15TF	K40			S40			
P50		MP6130	M50		MP7140	K50			S50			
		VP30RT			VP30RT							

MV1020

This grade has advanced wear and thermal shock resistance and also achieves stable cutting at unprecedented cutting speeds, especially when machining steel and ductile cast iron, thus greatly reducing work time.

MV1030

The new Al-Rich coating also provides excellent wear resistance. An unprecedented performance against sudden breakage was also realised especially during problematic wet cutting and when machining stainless steels.

MP6120

For general milling of steel.

MP6130

For interrupted milling of steel.

MP7130

For general milling of stainless steel.

MP7140

For unstable milling of stainless steel.

MC5020

For general milling of cast iron.

MP9120

For general milling of HRSA and titanium alloy.

MP9130

For interrupted and general milling of HRSA and Titanium alloy.

TF15

For general milling of aluminium.

VP15TF

For stable machining when the coating is combined with a high wear and fracture resistant carbide substrate.

MV1000 SERIES

COATED CARBIDE GRADE FOR MILLING

ADVANCED WEAR RESISTANCE

By adopting the newly developed Al-Rich coating technology, the (Al,Ti)N with a high Al content ratio displays very high hardness. This greatly improves oxidation and wear resistance.

ADVANCED THERMAL SHOCK RESISTANCE

The extreme heat resistance of this new series achieves amazing stability, not only during dry cutting, but also when wet cutting where inserts are usually prone to thermal cracking.



Graphical representation

EXCELLENT WELDING RESISTANCE

Smooth surface.

OUTSTANDING WEAR RESISTANCE

Newly developed Al-Rich coating.

EXCELLENT CHIPPING RESISTANCE FOR STABLE MACHINING

Newly developed bonding layer.

FRACTURE RESISTANCE FOR THE ULTIMATE STABILITY

Exclusive cemented carbide substrate.

WJX09



MULTI-FUNCTIONAL MILLING



GAMP : -6°
GAMF : -10°

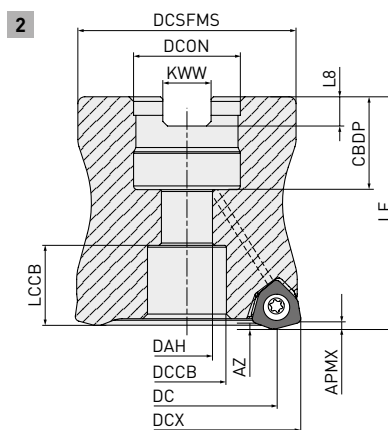
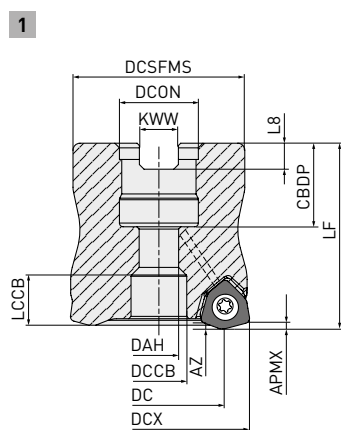

DCX	Set bolt	Geometry
Ø40	HFF08033H	
Ø50-63	HSC10030H	
Ø63.66	HSC12035H	

ARBOR TYPE

Order number	Stock	APMX	DC	DCON	DCX	LF	RMPX	RPMX*	WT	ZNF	Type
WJX09-040A04AR	●	1.2	28.8	16	40	40	2.9°	23200	0.21	4	2
WJX09-040A05AR	●	1.2	28.8	16	40	40	2.9°	23200	0.21	5	2
WJX09-050A04AR	●	1.2	38.8	22	50	50	2.0°	20000	0.42	4	1
WJX09-050A06AR	●	1.2	38.8	22	50	50	2.0°	20000	0.42	6	1
WJX09-052A06AR	●	1.2	40.8	22	52	50	1.9°	19500	0.45	6	1
WJX09-063A05AR	●	1.2	51.8	22	63	50	1.4°	19500	0.79	5	1
WJX09-063A07AR	●	1.2	51.8	22	63	50	1.4°	17300	0.79	7	1
WJX09-063X07AR	●	1.2	51.8	27	63	50	1.4°	17300	0.73	7	1
WJX09-066X07AR	●	1.2	54.8	27	66	50	1.4°	16800	0.79	7	1

1/2

* The maximum spindle speeds RPMX are set to ensure tool and insert stability.

1. When using the tool at high spindle speeds, ensure that the tool and arbor are correctly balanced.



WJX09 – ARBOR TYPE

MOUNTING DIMENSIONS

Order number	CBDP	DAH	DCCB	DCON	DCSFMS	DCX	KWW	LCCB	L8	Type
WJX09-040A04AR	18	8.5	12	16	37	40	8.4	-	5.6	2
WJX09-040A05AR	18	8.5	12	16	37	40	8.4	-	5.6	2
WJX09-050A04AR	20	11	17	22	47	50	10.4	17.2	6.3	1
WJX09-050A06AR	20	11	17	22	47	50	10.4	17.2	6.3	1
WJX09-052A06AR	20	11	17	22	47	52	10.4	17.2	6.3	1
WJX09-063A05AR	20	11	17	22	60	63	10.4	17.2	6.3	1
WJX09-063A07AR	20	11	17	22	60	63	10.4	17.2	6.3	1
WJX09-063X07AR	23	13	20	27	60	63	12.4	16.2	7.0	1
WJX09-066X07AR	23	13	20	27	60	66	12.4	16.2	7.0	1

2/2

SCREW-IN TYPE

P M K S H

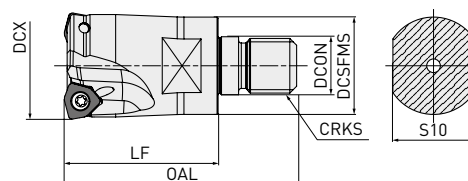

Order number	Stock	APMX	DC	DCON	DCX	LF	OAL	RMPX	AZ	WT	ZNF
WJX09R2502AM1235	●	1.2	14.0	12.5	25	35	57	4.7	0.89	0.10	2
WJX09R2503AM1235	●	1.2	14.0	12.5	25	35	57	4.7	0.89	0.10	3
WJX09R2802AM1235	●	1.2	16.9	12.5	28	35	57	5.6	1.2	0.12	2
WJX09R2803AM1235	●	1.2	16.9	12.5	28	35	57	5.6	1.2	0.11	3
WJX09R3202AM1645	●	1.2	20.9	17	32	45	68	4.2	1.2	0.23	2
WJX09R3203AM1645	●	1.2	20.9	17	32	45	68	4.2	1.2	0.21	3
WJX09R3502AM1645	●	1.2	23.8	17	35	45	68	3.6	1.2	0.25	2
WJX09R3503AM1645	●	1.2	23.8	17	35	45	68	3.6	1.2	0.24	3
WJX09R3504AM1645	●	1.2	23.8	17	35	45	68	3.6	1.2	0.23	4
WJX09R4003AM1645	●	1.2	28.8	17	40	45	68	2.9	1.2	0.27	3
WJX09R4004AM1645	●	1.2	28.8	17	40	45	68	2.9	1.2	0.27	4
WJX09R4005AM1645	●	1.2	28.8	17	40	45	68	2.9	1.2	0.27	5

1/2



WJX09 – SCREW-IN TYPE

MOUNTING DIMENSIONS

Order number	CRKS	S10	DCON	DCSFMS	DCX
WJX09R2502AM1235	M12	19	12.5	23.5	25
WJX09R2503AM1235	M12	19	12.5	23.5	25
WJX09R2802AM1235	M12	19	12.5	23.5	28
WJX09R2803AM1235	M12	19	12.5	23.5	28
WJX09R3202AM1645	M16	24	17.0	28.5	32
WJX09R3203AM1645	M16	24	17.0	28.5	32
WJX09R3502AM1645	M16	24	17.0	28.5	35
WJX09R3503AM1645	M16	24	17.0	28.5	35
WJX09R3504AM1645	M16	24	17.0	28.5	35
WJX09R4003AM1645	M16	24	17.0	28.5	40
WJX09R4004AM1645	M16	24	17.0	28.5	40
WJX09R4005AM1645	M16	24	17.0	28.5	40

2/2

SHANK TYPE



1

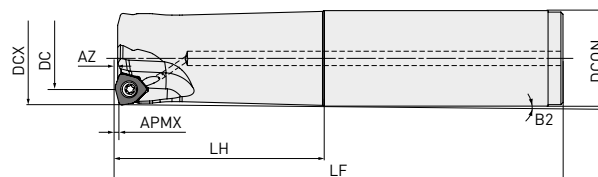

2

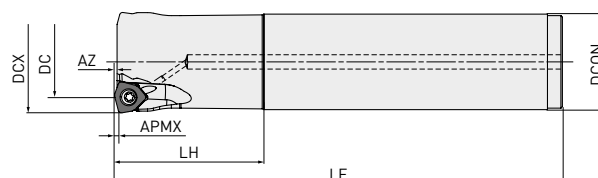

Order number	Stock	APMX	DC	DCON	DCX	LF	LH	B2	RMPX	AZ	ZNF	Type
WJX09R2502SA25S	●	1.2	14.0	25	25	140	60	1.09	4.7	0.89	2	1
WJX09R2503SA25S	●	1.2	14.0	25	25	140	60	1.09	4.7	0.89	3	1
WJX09R2802SA25S	★	1.2	16.9	25	28	140	40	—	5.6	1.2	2	2
WJX09R2803SA25S	●	1.2	16.9	25	28	140	40	—	5.6	1.2	3	2
WJX09R3202SA32S	★	1.2	20.9	32	32	150	70	0.93	4.2	1.2	2	1
WJX09R3203SA32S	●	1.2	20.9	32	32	150	70	0.93	4.2	1.2	3	1
WJX09R3503SA32S	★	1.2	23.8	32	35	150	50	—	3.6	1.2	3	2
WJX09R3504SA32S	★	1.2	23.8	32	35	150	50	—	3.6	1.2	4	2
WJX09R4003SA32S	★	1.2	28.8	32	40	150	50	—	2.9	1.2	3	2
WJX09R4004SA32S	●	1.2	28.8	32	40	150	50	—	2.9	1.2	4	2
WJX09R2502SA25L	●	1.2	14.0	25	25	200	120	0.54	4.7	0.89	2	1
WJX09R2503SA25L	★	1.2	14.0	25	25	200	120	0.54	4.7	0.89	3	1
WJX09R2802SA25L	●	1.2	16.9	25	28	200	40	—	5.6	1.2	2	2
WJX09R2803SA25L	★	1.2	16.9	25	28	200	40	—	5.6	1.2	3	2

1/2

WJX09 – SHANK TYPE

Order number	Stock	APMX	DC	DCON	DCX	LF	LH	B2	RMPX	AZ	ZNF	Type
WJX09R3202SA32L	★	1.2	20.9	32	32	200	120	0.54	4.2	1.2	2	1
WJX09R3203SA32L	●	1.2	20.9	32	32	200	120	0.54	4.2	1.2	3	1
WJX09R3503SA32L	★	1.2	23.8	32	35	200	50	—	3.6	1.2	3	2
WJX09R3504SA32L	★	1.2	23.8	32	35	200	50	—	3.6	1.2	4	2
WJX09R4003SA32L	★	1.2	28.8	32	40	250	50	—	2.9	1.2	3	2
WJX09R4004SA32L	★	1.2	28.8	32	40	250	50	—	2.9	1.2	4	2
WJX09R2502SA25EL	★	1.2	14.0	25	25	300	180	0.35	4.7	0.89	2	1
WJX09R2802SA25EL	★	1.2	16.9	25	28	300	40	—	5.6	1.2	2	2
WJX09R3202SA32EL	★	1.2	20.9	32	32	300	180	0.35	4.2	1.2	2	1
WJX09R3502SA32EL	★	1.2	23.8	32	35	300	50	—	3.6	1.2	2	2
WJX09R4003SA32EL	★	1.2	28.8	32	40	300	50	—	2.9	1.2	3	2

2/2



SPARE PARTS

Tool holder type	*		
	Clamp screw	Wrench (Insert)	Anti-seize lubricant
WJX09	TPS3R	TIP10D	MK1KS

* Clamp torque (N • m) : TPS3R = 2.0

INSERTS

	P	M	K	S	H
Steel	●	●	●	●	●
Stainless steel	●	●	●	●	●
Cast iron	●	●	●	●	●
Heat resistant alloy, Titanium	●	●	●	●	●
Hardened steel	●	●	●	●	●

Cutting conditions :
 ●: Stable cutting ●: General cutting
 ✖: Unstable cutting
Honing:
 E: Round F: Sharp edge S: Chamfer + round
 T: Chamfer Z: Stable

Order number	Class	Edge preparation	MP6120	MP6130	MC7020	MP7130	MP7140	MP9120	MP9130	NEW MV1020	NEW MV1030	VP15TF	VP30RT	IC	S	BS	RE	Geometry <i>Right hand insert only.</i>
JOMU090512ZZER-L	M	E	●	●	●	●	●	●	●	●	●	●	●	9.525	4.73	0.8	1.2	
JOMU090512ZZER-M	M	E	●	●	●	●	●	●	●	●	●	●	●	9.525	4.75	0.8	1.2	
JOMU090512ZZER-R	M	E	●	●	●					●	●	●	●	9.525	4.83	0.8	1.2	

(10 inserts in one case)



● : Inventory maintained. ★ : Inventory maintained in Japan.

WJX09

RECOMMENDED CUTTING CONDITIONS

ADJUSTMENT ACCORDING TO THE LENGTH OF OVERHANG

Multiply the recommended cutting conditions on pages 13–16 by the adjustment factor below.

	DCX	Overhang length	Adjustment value		
			Vc	ap	fz
Shank type Screw-in type	25–50	< 2.5×DCON	100 %	100 %	100 %
		3.0×DCON	90 %	100 %	90 %
		4.0×DCON	85 %	90 %	85 %
		5.0×DCON	80 %	85 %	80 %
		7.5×DCON	70 %	75 %	75 %
Arbor type	40–80	< 2.5×DCX	100 %	100 %	100 %
		3.0×DCX	85 %	100 %	90 %
		4.0×DCX	80 %	80 %	80 %
		5.0×DCX	75 %	75 %	60 %
		6.0×DCX	70 %	70 %	40 %
	≥100	8.0	100 %	100 %	100 %
		12.0	85 %	100 %	90 %
		16.0	80 %	80 %	80 %

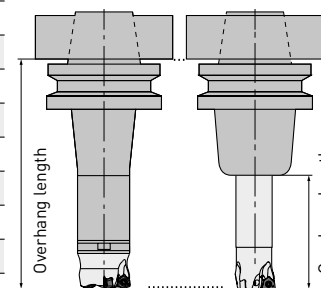

WJX09

RECOMMENDED CUTTING CONDITIONS

CUTTING SPEED (DRY CUTTING)

Material	Properties	Grade	Vc
Mild steel	≤180HB	MV1020	230 (180 – 280)
		MP6120	170 (120 – 220)
		MV1030	160 (100 – 220)
		MP6130	160 (110 – 200)
		VP15TF	170 (120 – 220)
		VP30RT	140 (100 – 180)
		MC7020	230 (180 – 280)
Carbon steel Alloy steel P	180–280HB	MV1020	220 (170 – 270)
		MP6120	160 (100 – 220)
		MV1030	150 (80 – 220)
		MP6130	140 (90 – 200)
		VP15TF	160 (100 – 220)
		VP30RT	120 (80 – 170)
		MC7020	220 (170 – 270)
	280–350HB	MV1020	220 (170 – 270)
		MP6120	160 (100 – 220)
		MV1030	150 (80 – 220)
		MP6130	140 (90 – 200)
		VP15TF	160 (100 – 220)
		VP30RT	120 (80 – 170)
		MC7020	220 (170 – 270)
Alloy tool steel	≤350HB (Annealing)	MP6120	160 (100 – 220)
		MP6130	140 (90 – 200)
		VP15TF	160 (100 – 220)
		VP30RT	120 (80 – 170)
		MC7020	220 (170 – 270)
Pre-hardened steel	35–45HRC	MP6120	120 (80 – 160)
		MP6130	100 (60 – 140)
		VP15TF	120 (80 – 160)
		VP30RT	90 (50 – 130)
		MC7020	—







WJX09 – CUTTING SPEED (DRY CUTTING)

Material	Properties	Grade	Vc
M	Austenitic stainless steel	MC7020	220 (170 – 270)
		MV1030	160 (130 – 200)
		MP7130	160 (130 – 200)
		MP7140	150 (120 – 180)
		VP30RT	150 (120 – 180)
	>200HB	MC7020	190 (140 – 240)
		MV1030	140 (80 – 200)
		MP7130	140 (100 – 200)
		MP7140	130 (80 – 180)
		VP30RT	130 (80 – 180)
Ferritic and martensitic stainless steel	≤200HB	MC7020	220 (170 – 270)
		MP7130	150 (100 – 200)
		MP7140	130 (80 – 180)
Duplex stainless steel	≤280HB	VP30RT	130 (80 – 180)
		MC7020	180 (130 – 230)
		MP7130	130 (80 – 180)
Precipitation hardening stainless steel	<450HB	MP7140	110 (60 – 160)
		VP30RT	110 (60 – 160)
		MC7020	170 (120 – 220)
K	Gray cast iron	MP7130	170 (120 – 220)
		MP7140	90 (50 – 130)
		VP30RT	90 (50 – 130)
	Ductile cast iron	MP7130	210 (160 – 260)
		VP15TF	180 (140 – 220)
		MV1030	160 (120 – 210)
S	Titanium alloy	MP7130	190 (140 – 240)
		VP15TF	160 (120 – 210)
		MV1030	130 (90 – 170)
	Heat resistant alloy	VP15TF	130 (90 – 170)
		MP9120	50 (30 – 65)
H	Hardened steel	MP9130	40 (30 – 60)
		VP15TF	50 (30 – 65)
		MP9120	30 (20 – 40)
		MP9130	40 (20 – 50)
		VP15TF	40 (20 – 50)
		VP15TF	70 (40 – 100)

WJX09 – DEPTH OF CUT / FEED PER TOOTH

Material	Properties	Cutting mode	ap		DCX 25.28(Z=2)	DCX 25.28(Z=3)	DCX 32-66		
					fz	fz	fz		
P	Mild steel	≤180HB	Dry	≤0.5	M, R	1.3 (0.4 – 2.0)	1.3 (0.4 – 2.0)	1.5 (0.5 – 2.0)	
					L	1.2 (0.4 – 1.6)	1.2 (0.4 – 1.6)	1.2 (0.4 – 1.6)	
					≤1.0	M, R	1.0 (0.3 – 1.3)	0.8 (0.3 – 1.0)	1.2 (0.4 – 1.5)
						L	0.8 (0.3 – 1.2)	0.8 (0.3 – 1.0)	0.8 (0.3 – 1.2)
					≤1.5	M, R	0.6 (0.3 – 1.0)	—	0.8 (0.4 – 1.2)
	Carbon steel Alloy steel	180-280HB	Dry	≤0.5	M, R	1.3 (0.4 – 1.7)	1.3 (0.4 – 1.7)	1.5 (0.4 – 2.0)	
					L	1.2 (0.3 – 1.5)	1.2 (0.3 – 1.5)	1.2 (0.3 – 1.5)	
					≤1.0	M, R	0.8 (0.3 – 1.0)	0.7 (0.3 – 0.9)	1.0 (0.3 – 1.3)
						L	0.7 (0.2 – 1.0)	0.7 (0.2 – 0.9)	0.7 (0.2 – 1.0)
					≤1.5	M, R	0.5 (0.3 – 0.7)	—	0.7 (0.3 – 1.0)
Carbon steel Alloy steel Alloy tool steel	280-350HB ≤350HB	Dry	≤0.5	M, R	1.3 (0.4 – 1.7)	1.3 (0.4 – 1.7)	1.5 (0.4 – 2.0)		
				L	1.2 (0.3 – 1.5)	1.2 (0.3 – 1.5)	1.2 (0.3 – 1.5)		
				≤1.0	M, R	0.8 (0.3 – 1.0)	0.7 (0.3 – 0.9)	1.0 (0.3 – 1.3)	
					L	0.7 (0.2 – 1.0)	0.7 (0.2 – 0.9)	0.7 (0.2 – 1.0)	
				≤1.5	M, R	0.5 (0.3 – 0.7)	—	0.7 (0.3 – 1.0)	
Pre-hardened steel	35-45HRC	Dry	≤0.5	M, R	1.0 (0.3 – 1.3)	1.0 (0.3 – 1.3)	1.2 (0.3 – 1.5)		
				L	0.8 (0.3 – 1.2)	0.8 (0.3 – 1.2)	0.8 (0.3 – 1.2)		
				≤1.0	M, R	0.6 (0.2 – 0.8)	0.6 (0.2 – 0.8)	0.8 (0.2 – 1.0)	
					L	0.5 (0.2 – 0.8)	0.5 (0.2 – 0.8)	0.5 (0.2 – 0.8)	
M	Austenitic stainless steel	—	Dry	≤0.5	L	0.8 (0.3 – 1.0)	0.8 (0.3 – 1.0)	0.8 (0.3 – 1.0)	
					M	1.0 (0.4 – 1.2)	1.0 (0.4 – 1.2)	1.0 (0.4 – 1.2)	
					≤1.0	L	0.6 (0.2 – 0.8)	0.6 (0.2 – 0.8)	0.6 (0.2 – 0.8)
						M	0.8 (0.3 – 1.0)	0.8 (0.3 – 1.0)	0.8 (0.3 – 1.0)
	Ferritic and martensitic stainless steel	≤200HB	Dry	≤0.5	L	0.8 (0.3 – 1.0)	0.8 (0.3 – 1.0)	0.8 (0.3 – 1.0)	
					M	1.0 (0.4 – 1.2)	1.0 (0.4 – 1.2)	1.0 (0.4 – 1.2)	
					≤1.0	L	0.6 (0.2 – 0.8)	0.6 (0.2 – 0.8)	0.6 (0.2 – 0.8)
						M	0.8 (0.3 – 1.0)	0.8 (0.3 – 1.0)	0.8 (0.3 – 1.0)
Duplex stainless steel	≤280HB	Dry	≤0.5	L	0.6 (0.3 – 0.8)	0.6 (0.3 – 0.8)	0.6 (0.3 – 0.8)		
				M	0.7 (0.3 – 1.0)	0.7 (0.3 – 1.0)	0.7 (0.3 – 1.0)		
				≤1.0	L	0.5 (0.2 – 0.7)	0.5 (0.2 – 0.7)	0.5 (0.2 – 0.7)	
					M	0.6 (0.3 – 0.7)	0.6 (0.3 – 0.7)	0.6 (0.3 – 0.7)	
Precipitation hardening stainless steel	<450HB	Dry	≤0.5	L	0.6 (0.3 – 0.8)	0.6 (0.3 – 0.8)	0.6 (0.3 – 0.8)		
				M	0.7 (0.3 – 1.0)	0.7 (0.3 – 1.0)	0.7 (0.3 – 1.0)		
				≤1.0	L	0.5 (0.2 – 0.7)	0.5 (0.2 – 0.7)	0.5 (0.2 – 0.7)	
					M	0.6 (0.3 – 0.7)	0.6 (0.3 – 0.7)	0.6 (0.3 – 0.7)	

WJX09 – DEPTH OF CUT / FEED PER TOOTH

Material	Properties	Cutting mode	ap		DCX 25.28(Z=2)	DCX 25.28(Z=3)	DCX 32-66											
					fz	fz	fz											
K	Gray cast iron	≤350MPa	Dry		≤0.5	M,R	1.3 (0.4 – 2.0)	1.3 (0.4 – 2.0)	1.5 (0.5 – 2.0)									
					L	1.2 (0.4 – 1.6)	1.2 (0.4 – 1.6)	1.2 (0.4 – 1.6)										
					≤1.0	M,R	1.0 (0.3 – 1.3)	0.8 (0.3 – 1.0)	1.2 (0.4 – 1.5)									
					L	1.0 (0.3 – 1.3)	0.8 (0.3 – 1.0)	1.0 (0.3 – 1.3)										
					≤1.5	M,R	0.6 (0.3 – 1.0)	—	0.8 (0.4 – 1.2)									
					L	0.6 (0.3 – 1.0)	—	0.8 (0.4 – 1.2)										
	Ductile cast iron	≤450MPa	Dry		≤0.5	M,R	1.3 (0.4 – 1.7)	1.3 (0.4 – 1.7)	1.5 (0.4 – 2.0)									
					L	1.0 (0.3 – 1.3)	1.0 (0.3 – 1.3)	1.0 (0.3 – 1.3)										
					≤1.0	M,R	0.8 (0.3 – 1.0)	0.7 (0.3 – 0.9)	1.0 (0.3 – 1.3)									
					L	0.8 (0.2 – 1.0)	0.7 (0.2 – 0.9)	0.8 (0.2 – 1.2)										
					≤1.5	M,R	0.5 (0.3 – 0.7)	—	0.7 (0.3 – 1.0)									
					L	0.5 (0.3 – 0.7)	—	0.7 (0.3 – 1.0)										
S	Titanium alloy	—	Wet		≤0.5	L	0.3 (0.2 – 0.6)	0.3 (0.2 – 0.6)	0.3 (0.2 – 0.6)									
					≤1.0	L	0.3 (0.2 – 0.4)	0.3 (0.2 – 0.4)	0.3 (0.2 – 0.4)									
					Heat resistant alloy	—	Wet		≤0.5	L,M,R	0.8 (0.3 – 1.2)	0.8 (0.3 – 1.2)	0.8 (0.3 – 1.2)					
									≤1.0	L,M,R	0.7 (0.3 – 1.0)	0.7 (0.3 – 1.0)	0.7 (0.3 – 1.0)					
									H	Hardened steel	40-55HRC	Dry		≤0.5	R,M	0.6 (0.3 – 1.0)	0.6 (0.3 – 1.0)	0.6 (0.3 – 1.0)
														≤1.0	R,M	0.5 (0.3 – 0.8)	0.4 (0.3 – 0.6)	0.5 (0.3 – 0.8)

2/2

1. Internal coolant is recommended for titanium alloy and heat resistant alloy machining.
2. To discharge chips effectively, use an air blow when machining. When the air blow is less effective at discharging chips, wet cutting is recommended.
3. When large vibration occurs, reduce the cutting conditions.
4. For interrupted cutting, reduce the cutting speed and feed rate by 20 %.
5. If ap is set at 1.2 mm or more, avoid wall machining or ramping.

WJX09

MAXIMUM CAPACITIES BY MODE

RAMPING

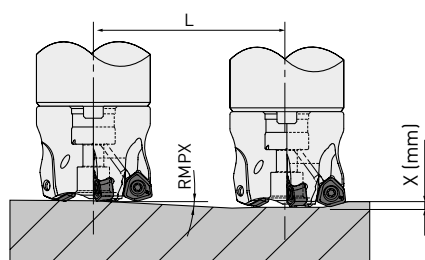

HELICAL MILLING

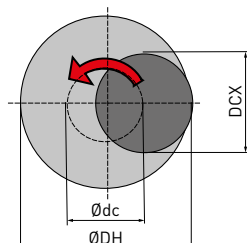

How to derive a locus of the centre of the tool.

$$\text{ØDC} = \text{ØDH} - \text{DCX}$$

Locus of the centre of the tool Desired hole diameter Cutting diameter maximum

Tool holder type	APMX	DC	DCX	AZ ^{*1}	Ramping		Helical milling (Blind hole, Flat bottom)		Helical milling (Through hole)
					RMPX	L (mm) ^{*2}	DH		DH
						x=1	Min.	Max.	Min.
WJX09R25	1.2	14	25	0.8	4.7	12.2	38	47	34
WJX09R28	1.2	16.9	28	1.2	5.6	10.2	44	53	38
WJX09R32	1.2	20.9	32	1.2	4.2	13.7	52	61	46
WJX09R35	1.2	23.8	35	1.2	3.6	15.9	58	67	52
WJX09R40	1.2	28.8	40	1.2	2.9	19.8	68	77	61
WJX09-040	1.2	28.8	40	1.2	2.9	19.8	68	77	61
WJX09-050	1.2	38.8	50	1.2	2	28.7	88	97	81
WJX09R050	1.2	38.8	50	1.2	2	28.7	88	97	81
WJX09-052	1.2	40.8	52	1.2	1.9	30.2	92	101	85
WJX09-063	1.2	51.8	63	1.2	1.4	41	114	123	107
WJX09R063	1.2	51.8	63	1.2	1.4	41	114	123	107
WJX09-066	1.2	54.8	66	1.2	1.4	41	120	129	113

- When ramping and helical milling, it is recommended to reduce the feed per tooth.
- Caution – When ramping, helical milling and drilling, long continuous chips may be scattered.

3. Helical milling

To obtain a flat bottom surface when helical milling, it requires removal of “the uncut part” in the centre of the work material.
When helical milling, make sure that the depth of cut per helical pass doesn't exceed the maximum depth of cut (APMX).

4. Drilling

When drilling, set the axial feed per revolution at 0.2 mm/rev or less.

*1 AZ = max. plunging

*2 L = Required distance for X mm depth

WJX14



MULTI-FUNCTIONAL MILLING



GAMP : -6°
 GAMF : -10°
 T : +13°
 I : +7°



GAMP : -7°
 GAMF : -10°
 T : +12°
 I : +7°

A 7 mm Allen wrench is used to tighten the set bolt (included).

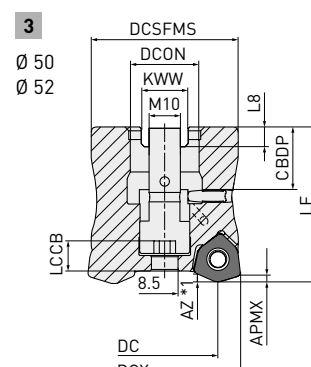
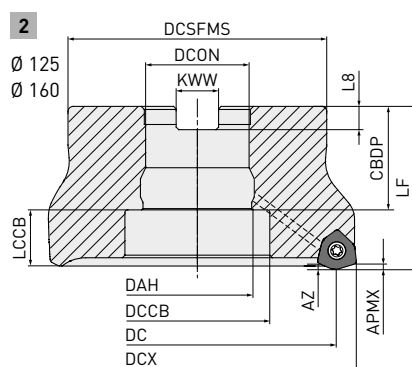
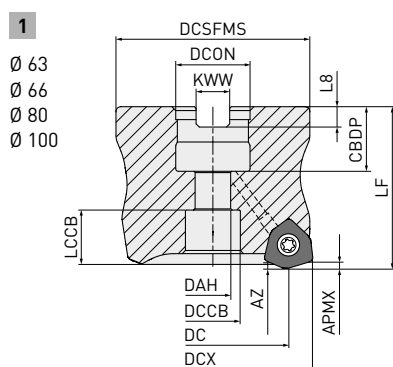

Right hand tool holder only.

DCX	Set bolt	Geometry
Ø 63 (22)	HSC10030H	
Ø 63 (27), Ø66, Ø80	HSC12035H	
Ø 100	HSC16040H	
Ø 125, Ø160	MBA20040H	

ARBOR TYPE

Order number	Stock	APMX	DC	DCON	DCX	LF	RMPX	RMPX*	WT	ZNF	Type
WJX14-050A03AR	★	2	34.5	22	50	50	4.4°	5000	0.4	3	3
WJX14-050A04AR	●	2	34.5	22	50	50	4.4°	5000	0.4	4	3
WJX14-052A04AR	●	2	36.5	22	52	50	4.1°	5000	0.4	4	3
WJX14-063A04AR	●	2	47.5	22	63	50	3°	18200	0.7	4	1
WJX14-063A05AR	★	2	47.5	22	63	50	3°	18200	0.7	5	1
WJX14-063X05AR	●	2	47.5	27	63	50	3°	18200	0.6	5	1
WJX14-066X05AR	●	2	50.4	27	66	50	2.8°	17700	0.7	5	1
WJX14-080A05AR	●	2	64.4	27	80	50	2.1°	15600	1.2	5	1
WJX14-080A06AR	●	2	64.4	27	80	50	2.1°	15600	1.2	6	1
WJX14-100A06AR	★	2	84.4	32	100	63	1.5°	13500	2.5	6	1
WJX14-100A07AR	★	2	84.4	32	100	63	1.5°	13500	2.5	7	1
WJX14-125B07AR	★	2	109.4	40	125	63	1.2°	11600	3.2	7	2
WJX14-125B09AR	★	2	109.4	40	125	63	1.2°	11600	3.1	9	2
WJX14-160B09AR	★	2	144.4	40	160	63	0.8°	9900	4.9	9	2

1/1

* The maximum spindle speeds RPMX are set to ensure tool and insert stability.

1. When using the tool at high spindle speeds, ensure that the tool and arbor are correctly balanced.



WJX14 – ARBOR TYPE

MOUNTING DIMENSIONS

Order number	CBDP	DAH	DCCB	DCON	DCSFMS	DCX	KWW	LCCB	L8	Type
WJX14-050A03AR	20	—	—	22	47	50	10.4	18.3	6.3	3
WJX14-050A04AR	20	—	—	22	47	50	10.4	18.3	6.3	3
WJX14-052A04AR	20	—	—	22	47	52	10.4	18.3	6.3	3
WJX14-063A04AR	20	11	17	22	60	63	10.4	16.7	6.3	1
WJX14-063A05AR	20	11	17	22	60	63	10.4	16.7	6.3	1
WJX14-063X05AR	23	13	20	27	60	63	12.4	15.7	7	1
WJX14-066X05AR	23	13	20	27	60	66	12.4	15.7	7	1
WJX14-080A05AR	23	13	20	27	76	80	12.4	15.7	7	1
WJX14-080A06AR	23	13	20	27	76	80	12.4	15.7	7	1
WJX14-100A06AR	26	17	26	32	96	100	14.4	25.7	8	1
WJX14-100A07AR	26	17	26	32	96	100	14.4	25.7	8	1
WJX14-125B07AR	40	42	56	40	100	125	16.4	21.7	9	2
WJX14-125B09AR	40	42	56	40	100	125	16.4	21.7	9	2
WJX14-160B09AR	40	42	56	40	100	160	16.4	21.7	9	2

1/1



SHANK TYPE

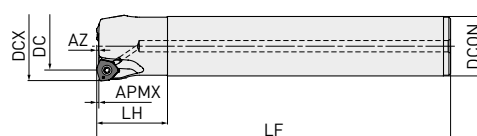

Right hand tool holder only.

Order number	Stock	APMX	DC	DCON	DCX	LF	LH	RMPX	RPMX*	ZNF
WJX14R5003SA42S	★	2	34.5	42	50	150	50	4.4°	21200	3
WJX14R5003SA42L	★	2	34.5	42	50	250	50	4.4°	21200	3





* The maximum spindle speeds RPMX are set to ensure tool and insert stability.

1. When using the tool at high spindle speeds, ensure that the tool and arbor are correctly balanced.



WJX14



SPARE PARTS

Tool holder type	 *	 	
	Clamp screw	Wrench (Insert)	Anti-seize lubricant
WJX14 Arbor type	TS5R	TKY20T	MK1KS
WJX14 Shank type	TS5R	TKY20D	MK1KS

* Clamp torque (N • m) : TS5R = 5.0

INSERTS

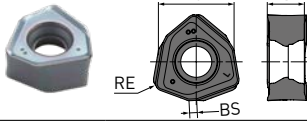
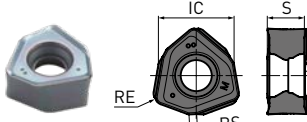
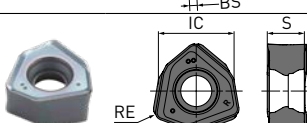
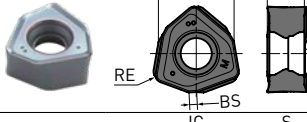
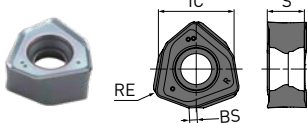
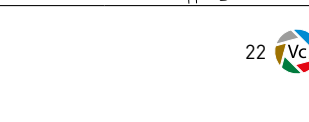
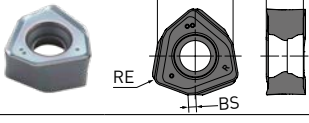
P	Steel	●	✖	●	●	●	●	●	●	●	●	●	●	Cutting conditions : ●: Stable cutting ●: General cutting ✖: Unstable cutting
M	Stainless steel			●	●	✖				●	●	●	✖	
K	Cast iron							●	●				✖	Honing: E: Round F: Sharp edge S: Chamfer + round T: Chamfer Z: Stable
S	Heat resistant alloy, Titanium							●	✖				●	
H	Hardened steel												●	

Order number	Class	Honing	MP6120	MP6130	MC7020	MP7130	MP7140	MP9120	MP9130	NEW MV1020	NEW MV1030	VP15TF	VP30RT	IC	S	BS	RE	Geometry		
																		<i>Right hand insert only.</i>		
JOMU140715ZZER-L	M	E	●	●	●	●	●	●	●	●	●	★	★	14	6.575	1.3	1.5			
JOMU140715ZZER-M	M	E	●	●	●	●	●	●	●	●	●	★	★	14	6.63	1.3	1.5			
JOMU140715ZZER-R	M	E	●	●	●					●	●	●	●	14	6.751	1.3	1.5			

(10 inserts in one case)

WJX14

RECOMMENDED CUTTING CONDITIONS

ADJUSTMENT ACCORDING TO THE LENGTH OF OVERHANG

Multiply the recommended cutting conditions on pages 22–25 by the adjustment factor below.

	DCX	Overhang length	Adjustment value		
			Vc	ap	fz
Shank type	50	< 2.5×DCON	100 %	100 %	100 %
		3.0×DCON	90 %	100 %	90 %
		4.0×DCON	80 %	80 %	90 %
Arbor type	63–80	< 2.5×DCX	100 %	100 %	100 %
		3.0×DCX	85 %	100 %	90 %
		4.0×DCX	80 %	80 %	80 %
		5.0×DCX	75 %	75 %	60 %
	>100	6.0×DCX	70 %	70 %	40 %
		200 mm	100 %	100 %	100 %
		300 mm	85 %	100 %	90 %
		400 mm	80 %	80 %	80 %

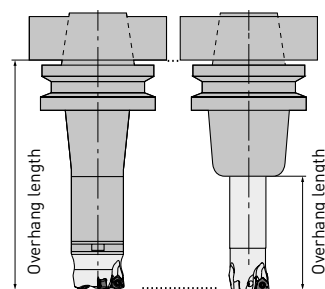

WJX14 – CUTTING SPEED (DRY CUTTING)

Material	Properties	Grade	Vc
Mild steel	≤180HB	MV1020	220 (170 – 270)
		MP6120	150 (100 – 200)
		MP6130	140 (90 – 180)
		VP15TF	150 (100 – 200)
		MV1030	130 (80 – 180)
		VP30RT	120 (80 – 160)
Carbon steel Alloy steel	180–280HB	MV1020	200 (150 – 250)
		MP6120	140 (80 – 200)
		MV1030	120 (60 – 180)
		MP6130	120 (70 – 180)
		VP15TF	140 (80 – 200)
P Carbon steel Alloy steel	280–350HB	VP30RT	100 (60 – 150)
		MP6120	140 (80 – 200)
		MP6130	120 (70 – 180)
		VP15TF	140 (80 – 200)
Alloy tool steel	≤350HB (Annealing)	VP30RT	100 (60 – 150)
		MP6120	140 (80 – 200)
		MP6130	120 (70 – 180)
Pre-hardened steel	35–45HRC	VP15TF	140 (80 – 200)
		MP6120	110 (70 – 150)
		MP6130	90 (50 – 130)
Austenitic stainless steel	≤200HB	VP30RT	110 (70 – 150)
		MP6120	140 (80 – 200)
		MP6130	120 (70 – 180)
		VP15TF	140 (80 – 200)
		VP30RT	100 (60 – 150)
	>200HB	MP6120	110 (70 – 150)
		MP6130	90 (50 – 130)
		VP15TF	110 (70 – 150)
		VP30RT	80 (40 – 120)
		MC7020	220 (170–270)
M Ferritic and martensitic stainless steel	≤200HB	MV1030	160 (130 – 200)
		MP7130	160 (130 – 200)
		MP7140	150 (120 – 180)
		VP30RT	150 (120 – 180)
		MC7020	190 (140 – 240)
	>200HB	MV1030	140 (100 – 200)
		MP7130	140 (100 – 200)
		MP7140	130 (80 – 180)
		VP30RT	130 (80 – 180)
		MC7020	220 (170 – 270)
Duplex stainless steel	≤280HB	MP7130	150 (100 – 200)
		MP7140	130 (80 – 180)
		VP30RT	130 (80 – 180)
		MC7020	180 (130 – 230)
Precipitation hardening stainless steel	<450HB	MP7130	130 (80 – 180)
		MP7140	110 (60 – 160)
		VP30RT	110 (60 – 160)
		MC7020	170 (120 – 220)
		MP7130	110 (60 – 160)
		MP7140	90 (50 – 130)
		VP30RT	90 (50 – 130)

WJX14 – CUTTING SPEED (DRY CUTTING)

	Material	Properties	Grade	Vc
K	Gray cast iron	≤350MPa	VP15TF	160 (120 – 200)
			MV1020	200 (150 – 250)
	Ductile cast iron	≤450MPa	MV1030	150 (100 – 200)
			VP15TF	150 (100 – 200)
	Ductile cast iron	≤800MPa	MV1020	180 (130 – 230)
			MV1030	120 (80 – 160)
S	Heat resistant alloy	—	VP15TF	120 (80 – 160)
			MP9120	40 (20 – 50)
H	Hardened steel	40-55HRC	MP9130	30 (20 – 40)
			VP15TF	40 (20 – 50)
			VP15TF	70 (40 – 100)

2/2

WJX14 – DEPTH OF CUT / FEED PER TOOTH

Material	Properties	ap		DCX=50.52	DCX>63	
				fz	fz	
P	Mild steel	≤180HB	≤1	M, R	1.5 [0.6 – 2.5]	1.7 [0.6 – 2.8]
			≤1	L	1.2 [0.4 – 2.0]	1.2 [0.4 – 2.0]
			≤1.5	M, R	1.3 [0.6 – 2.0]	1.5 [0.6 – 2.5]
			≤1.5	L	1.0 [0.4 – 1.8]	1.0 [0.4 – 1.8]
			≤2	M, R	1.2 [0.6 – 2.0]	1.3 [0.6 – 2.5]
			≤2	L	0.8 [0.4 – 1.7]	0.8 [0.4 – 1.7]
			≤2.5	M, R	0.8 [0.3 – 1.5]	1.0 [0.3 – 1.6]
			≤3	M, R	0.4 [0.2 – 1.0]	0.5 [0.2 – 1.2]
	Carbon steel Alloy steel	180 – 280HB	≤1	M, R	1.5 [0.5 – 2.0]	1.7 [0.5 – 2.5]
			≤1	L	1.0 [0.3 – 1.7]	1.0 [0.3 – 1.7]
			≤1.5	M, R	1.2 [0.5 – 1.7]	1.3 [0.5 – 2.5]
			≤1.5	L	0.8 [0.3 – 1.5]	0.8 [0.3 – 1.5]
			≤2	M, R	1.0 [0.5 – 1.5]	1.2 [0.5 – 2.0]
			≤2	L	0.7 [0.3 – 1.2]	0.7 [0.3 – 1.2]
≤2.5			M, R	0.7 [0.3 – 1.2]	0.9 [0.3 – 1.5]	
≤3			M, R	0.3 [0.2 – 0.8]	0.4 [0.2 – 1.0]	
Carbon steel Alloy steel Alloy tool steel	280 – 350HB ≤350HB (Annealing)	≤1	M, R	1.5 [0.5 – 2.0]	1.7 [0.5 – 2.5]	
		≤1	L	1.0 [0.3 – 1.7]	1.0 [0.3 – 1.7]	
		≤1.5	M, R	1.2 [0.5 – 1.7]	1.3 [0.5 – 2.2]	
		≤1.5	L	0.8 [0.3 – 1.5]	0.8 [0.3 – 1.5]	
		≤2	M, R	1.0 [0.5 – 1.5]	1.2 [0.5 – 2.0]	
		≤2	L	0.7 [0.3 – 1.2]	0.7 [0.3 – 1.2]	
		≤2.5	M, R	0.7 [0.3 – 1.2]	0.9 [0.3 – 1.5]	
		≤3	M, R	0.3 [0.2 – 0.8]	0.4 [0.2 – 1.0]	
Pre-hardened steel	35 – 45HRC	≤1	M, R	1.3 [0.4 – 1.7]	1.5 [0.4 – 2.0]	
		≤1	L	0.7 [0.3 – 1.2]	0.7 [0.3 – 1.2]	
		≤1.5	M, R	1.0 [0.4 – 1.5]	1.2 [0.4 – 1.5]	
		≤1.5	L	0.6 [0.3 – 1.0]	0.6 [0.3 – 1.0]	
		≤2	M, R	0.8 [0.4 – 1.2]	1.0 [0.4 – 1.3]	
		≤2	L	0.5 [0.3 – 0.8]	0.5 [0.3 – 0.8]	
		≤1	L	0.8 [0.3 – 1.2]	0.8 [0.3 – 1.2]	
		≤1	M	1.0 [0.5 – 1.2]	1.0 [0.5 – 1.2]	
M	Austenitic stainless steel	≤200HB	≤1.5	L	0.8 [0.3 – 1.0]	0.8 [0.3 – 1.0]
			≤1.5	M	1.0 [0.5 – 1.0]	1.0 [0.5 – 1.0]
			≤1	L	0.8 [0.3 – 1.2]	0.8 [0.3 – 1.2]
			≤1	M	1.0 [0.5 – 1.2]	1.0 [0.5 – 1.2]
	Ferritic and martensitic stainless steel	≤200HB	≤1.5	L	0.8 [0.3 – 1.0]	0.8 [0.3 – 1.0]
			≤1.5	M	1.0 [0.5 – 1.0]	1.0 [0.5 – 1.0]
			≤1	L	0.6 [0.3 – 1.0]	0.6 [0.3 – 1.0]
	Duplex stainless steel	≤280HB	≤1	M	0.8 [0.4 – 1.0]	0.8 [0.4 – 1.0]
			≤1.5	L	0.6 [0.3 – 0.8]	0.6 [0.3 – 0.8]
			≤1.5	M	0.8 [0.4 – 0.8]	0.8 [0.4 – 0.8]
Precipitation hardening stainless steel	≤450HB	≤1	L	0.6 [0.3 – 1.0]	0.6 [0.3 – 1.0]	
		≤1	M	0.8 [0.4 – 1.0]	0.8 [0.4 – 1.0]	
		≤1.5	L	0.6 [0.3 – 0.8]	0.6 [0.3 – 0.8]	
≤1.5	M	0.8 [0.4 – 0.8]	0.8 [0.4 – 0.8]			

WJX14 – DEPTH OF CUT / FEED PER TOOTH

Material	Properties	ap 	DCX=50.52		DCX>63	
			fz		fz	
Gray cast iron	≤350MPa	≤1 M, R	1.7 [0.6 – 2.5]	1.8 [0.6 – 2.8]		
		≤1 L	1.3 [0.4 – 2.0]	1.3 [0.4 – 2.0]		
		≤1.5 M, R	1.5 [0.6 – 2.0]	1.7 [0.6 – 2.5]		
		≤1.5 L	1.2 [0.4 – 1.8]	1.2 [0.4 – 1.8]		
		≤2 M, R	1.3 [0.6 – 2.0]	1.5 [0.6 – 2.5]		
		≤2 L	1.0 [0.4 – 1.5]	1.0 [0.4 – 1.5]		
		≤2.5 M, R	0.8 [0.3 – 1.5]	1.0 [0.3 – 1.6]		
		≤3 M, R	0.4 [0.2 – 1.0]	0.5 [0.2 – 1.2]		
Ductile cast iron	≤450MPa	≤1 M, R	1.5 [0.5 – 2.0]	1.7 [0.5 – 2.5]		
		≤1 L	1.2 [0.3 – 2.0]	1.2 [0.3 – 2.0]		
		≤1.5 M, R	1.3 [0.5 – 1.8]	1.5 [0.5 – 2.0]		
		≤1.5 L	1.0 [0.3 – 1.7]	1.0 [0.3 – 1.7]		
		≤2 M, R	1.2 [0.5 – 1.8]	1.3 [0.5 – 2.0]		
		≤2 L	0.8 [0.3 – 1.5]	0.8 [0.3 – 1.5]		
	≤800MPa	≤2.5 M, R	0.7 [0.3 – 1.2]	0.9 [0.3 – 1.5]		
		≤3 M, R	0.3 [0.2 – 0.8]	0.4 [0.2 – 1.0]		
		≤1 M, R	1.3 [0.4 – 1.8]	1.5 [0.4 – 2.0]		
		≤1 L	1.0 [0.3 – 1.7]	1.0 [0.3 – 1.7]		
		≤1.5 M, R	1.2 [0.4 – 1.5]	1.3 [0.4 – 1.8]		
		≤1.5 L	0.8 [0.3 – 1.5]	0.8 [0.3 – 1.5]		
Titanium alloy	—	≤2 M, R	1.0 [0.4 – 1.5]	1.2 [0.4 – 1.8]		
		≤2 L	0.7 [0.3 – 1.2]	0.7 [0.3 – 1.2]		
		≤1 L	0.3 [0.2 – 0.6]	0.3 [0.2 – 0.6]		
Heat resistant alloy	—	≤1.5 L	0.3 [0.2 – 0.5]	0.3 [0.2 – 0.5]		
		≤2 L	0.3 [0.2 – 0.4]	0.3 [0.2 – 0.4]		
		≤1 L, M, R	1.0 [0.3 – 1.3]	1.0 [0.3 – 1.3]		
Hardened steel	40 – 55HRC	≤1.5 L, M, R	0.8 [0.3 – 1.2]	0.8 [0.3 – 1.2]		
		≤2 L, M, R	0.7 [0.3 – 1.2]	0.7 [0.3 – 1.2]		
		≤1 R, M	0.8 [0.3 – 1.2]	0.8 [0.3 – 1.2]		
		≤1.5 R, M	0.6 [0.3 – 1.0]	0.6 [0.3 – 1.0]		
		≤2 R, M	0.5 [0.3 – 0.8]	0.5 [0.3 – 0.8]		

2/2

1. Internal coolant is recommended for titanium alloy and heat resistant alloy machining.
2. To discharge chips effectively, use an air blow when machining. When the air blow is less effective at discharging chips, wet cutting is recommended.
3. When large vibration occurs, reduce the cutting conditions.
4. For interrupted cutting, reduce the cutting speed and feed rate by 20 %.
5. If ap is set at 2 mm or more, avoid wall machining or ramping.

WJX14

MAXIMUM CAPACITIES BY MODE

RAMPING

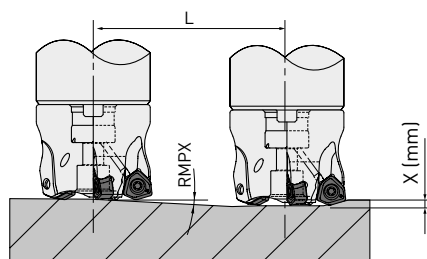

HELICAL MILLING

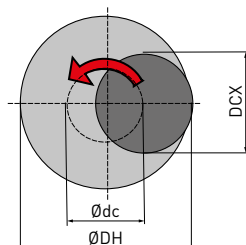

How to derive a locus of the centre of the tool.

$$\text{ØDC} = \text{ØDH} - \text{DCX}$$

Locus of the centre of the tool Desired hole diameter Cutting diameter maximum

Tool holder type	APMX	DC	DCX	AZ ^{*1}	Ramping			Helical milling (Blind hole, Flat bottom)		Helical milling (Through hole)
					RMPX	L (mm) ^{*2}		DH		DH
						x=1	x=2	Min.	Max.	Min.
WJX14-063	2	47.5	63	2.1	3.0°	19.1	38.2	108	123	99
WJX14-066	2	50.4	66	2.1	2.8°	20.5	40.9	114	129	105
WJX14-080	2	64.4	80	2.1	2.1°	27.3	54.6	142	157	133
WX14-100	2	84.4	100	2.1	1.5°	38.2	76.4	182	197	173
WJX14-125	2	109.4	125	2.1	1.2°	47.8	95.5	232	247	223
WJX14-160	2	144.4	160	2.1	0.8°	71.7	143.3	302	317	293

- When ramping and helical milling, it is recommended to reduce the feed per tooth.
- Caution – When ramping, helical milling and drilling, long continuous chips may be scattered.
- Helical milling**
To obtain a flat bottom surface when helical milling, it requires removal of “the uncut part” in the centre of the work material. When helical milling, make sure that the depth of cut per helical pass doesn’t exceed the maximum depth of cut (APMX).
- Drilling**
When drilling, set the axial feed per revolution at 0.2 mm/rev or less.

*1 AZ = max. Plunging

*2 L = Required distance for X mm depth

OPERATIONAL GUIDANCE

DEPTH OF CUT

The straight cutting edge covers a maximum depth of cut up to 2.0 mm (APMX).

When face milling steels and cast iron, the depth of cut can be set at up to 3.0 mm, until the corner radius is reached.

When exceeding 2.0 mm depth of cut, decrease the feed rate. See the cutting conditions on page 21–22 for reference.

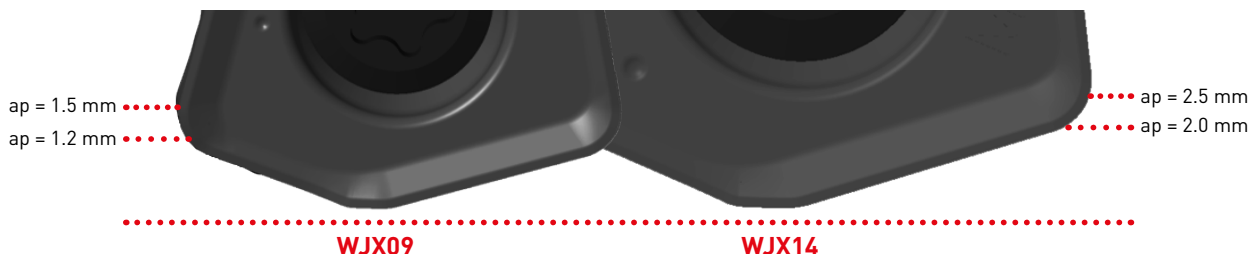

REMAINING STOCK

Programme the WJX as a radius cutter. The approximate remaining stock K for the programme is shown on the right. See the diagram below for the remaining stock H for vertical walls.

Remaining stock K

WJX 09 = 0.94 mm
WJX 14 = 1.41 mm

Corner RE (approx.)

WJX09 = R 2.0 mm
WJX14 = R 3.0 mm

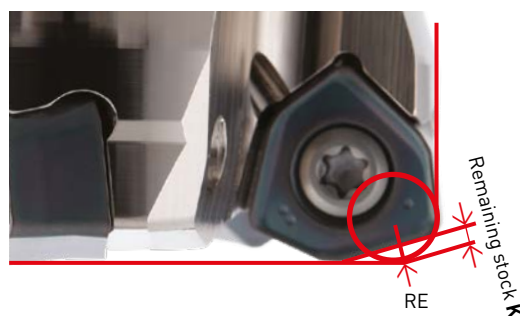

WJX09

ap	Remaining stock H
0.5	0.02
1.0	0.07
1.2	0.09

WJX14

ap	Remaining stock H
1.0	0.05
1.5	0.08
2.0	0.12

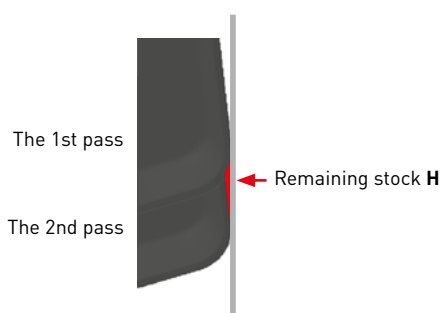

CUTTER DIAMETER AND FLAT SURFACE MILLING

The maximum cutting diameter (DCX) shown in the WJX items table is not the same as the possible dimensions for face milling a flat surface. The possible dimensions for face milling are given as the DC value. Please note that this is smaller than the DCX value.



EUROPEAN SALES COMPANIES

GERMANY

MMC HARTMETALL GMBH
Comeniusstr. 2 . 40670 Meerbusch
Phone +49 2159 91890 . Fax +49 2159 918966
Email admin@mmchg.de

U.K.

MMC HARDMETAL U.K. LTD.
Mitsubishi House . Galena Close . Tamworth . Staffs. B77 4AS
Phone +44 1827 312312
Email sales@mitsubishicarbide.co.uk

SPAIN

MITSUBISHI MATERIALS ESPAÑA, S.A.
Calle Emperador 2 . 46136 Museros /Valencia
Phone +34 96 1441711 . Fax +34 96 1443786
Email comercial@mmevalencia.es

FRANCE

MMC METAL FRANCE S.A.R.L.
6, Rue Jacques Monod . 91400 Orsay
Phone +33 1 69 35 53 53 . Fax +33 1 69 35 53 50
Email mmfsales@mmc-metal-france.fr

POLAND

MMC HARDMETAL POLAND SP. Z O.O
Al. Armii Krajowej 61 . 50-541 Wrocław
Phone +48 71335 1620 . Fax +48 71335 1621
Email sales@mitsubishicarbide.com.pl

ITALY

MMC ITALIA S.R.L.
Viale Certosa 144 . 20156 Milano
Phone +39 0293 77031 . Fax +39 0293 589093
Email info@mmc-italia.it

TURKEY

MMC HARTMETALL GMBH ALMANYA - İZMİR MERKEZ ŞUBESİ
Adalet Mahallesi Anadolu Caddesi No: 41-1 . 15001 35530 Bayraklı /İzmir
Phone +90 232 5015000 . Fax +90 232 5015007
Email info@mmchg.com.tr

www.mmc-carbide.com

DISTRIBUTED BY:

□

□

┌

└

B235E 

Published by: MMC Hartmetall GmbH – A Sales Company of  MITSUBISHI MATERIALS | 2024.03